

86cm integrated rangehood with Hob2Hood, 800m³/hr extraction rate, 3 fan speed plus Boost, and dishwasher safe filters.



Product Details

FEATURES

Hob2Hood	Powerful 800m ³ /hr extraction rate	LED lighting	3 speed fan + Boost mode
Dishwasher safe mesh filters	Dark Stainless Steel Finish	Ducted or recirculating options	Electronic push button options

BENEFITS

Clear the air with Hob2Hood

With Hob2Hood technology, compatible rangehoods work seamlessly with your induction or ceramic cooktop to clear your kitchen of cooking smells and steam. As you start cooking, the rangehood will automatically turn on then intuitively adjust the fan speed and airflow to match your cooking. How's that for hands-free convenience?

Clear the air quickly

Our rangehoods offer powerful extraction rates ensuring your kitchen is clear of cooking odours, vapours and excess heat in no time at all.

Low energy, long lasting LED

With low energy use and a high illumination performance, long-lasting LED lights make it easy to keep an eye on your delicious cooking.

Easy-clean filters

For ease and convenience, our easily removed aluminium micro-mesh filters can simply be washed safely in your dishwasher or hand washed. Keep your rangehood looking great and performing well with next to no effort.

Specifications

PRODUCT PROFILE

Domestic warranty details (yrs)	2
---------------------------------	---

Type of Rangehood	integrated under cupboard
-------------------	---------------------------

Nominal width (cm)	86
--------------------	----

Finish of Rangehood	Dark stainless steel
---------------------	----------------------

MOTOR/FAN

Number of fans	1
----------------	---

Number of fans speeds	3
-----------------------	---

Type of motor	tangential
---------------	------------

Perimeter extraction	No
----------------------	----

Maximum airflow M3/Hr	800
-----------------------	-----

Noise level dB high	69
---------------------	----

Noise level dB low	53
--------------------	----

Number of motors	1
------------------	---

Wattage of motor	305
------------------	-----

DIMENSIONS

Total product height (mm)	249
---------------------------	-----

Total product width (mm)	866
--------------------------	-----

Total product depth (mm)	292
--------------------------	-----

POWER

Electricity supply required (Kw)	0.305
----------------------------------	-------

Connection plug	10
-----------------	----

DIMENSIONS

Diameter of ducting (mm)	150
Minimum installation height from cooking surface Gas (mm)	620
Minimum installation height from cooking surface Electric (mm)	600
Cut out width (mm)	833
Cut out depth (mm)	262

CONTROLS

Control panel	electronic push button
Safety/ display indicators	clean filter indicator, auto thermal cutout safety switch
Hob2Hood function	Yes

LIGHTS

Number of lights	2
Wattage of light	3.5

FILTERS

Number of filters	2
Type of filter	multilayer aluminum micromesh filters
Dishwasher safe	Yes

DUCTING / RECIRCULATION

Ducting	optional accessory
Top or rear duct hole	top

LIGHTS

Type of light	LED
---------------	-----

DUCTING / RECIRCULATION

Recirculation option	Yes
Recirculation kit	optional accessory
Front recirculating option	No
Type of filter	Charcoal
Filter	Optional
Number of optional filters required	two
Ducting diameter (mm)	150

SHIPPING

Shipping Volume (m3)	0.15
Shipping Weight (Kg)	11.5
Product Weight (Kg)	9
Pack Dimensions Height (mm)	430
Pack Dimension Width (mm)	980
Pack Dimension Depth (mm)	365

STUFFING QUANTITIES

20ft	170
40ft	367
40ft HC	432

Dimensions

Integrated rangehood

WRI825BC

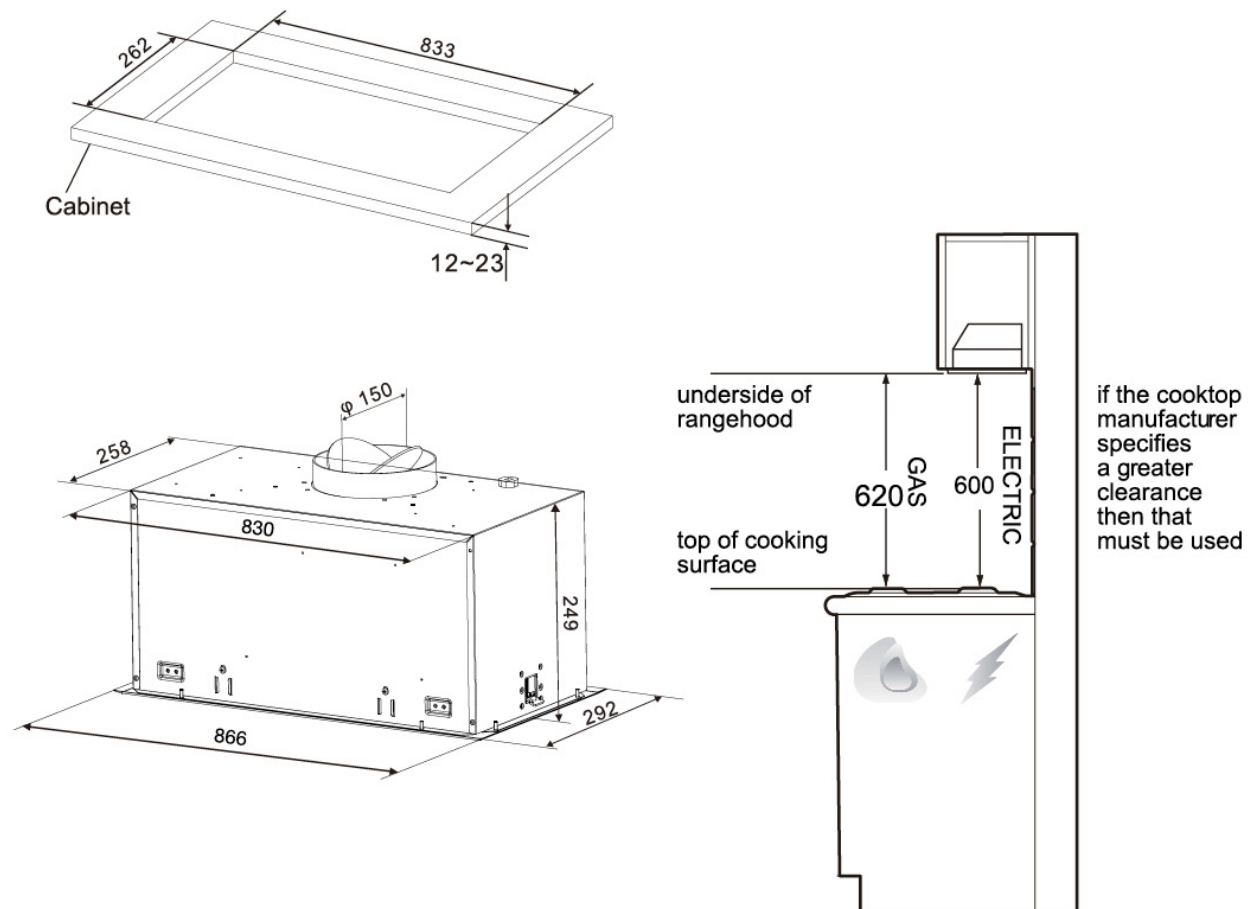

IMPORTANT

These dimensions are a guide only. All measurements are in millimetres (mm). For complete installation instructions, refer to the manual provided with product.

Terms and Conditions

IMPORTANT

This is a guide of product dimensions only. For complete installation instructions, refer to the manual provided with product.

PRODUCT INFORMATION

The descriptors and illustrations in this publication apply to the specific products and models described as at the date of issue. Under our policy of continuous product development, product specifications may change without notice. Prospective purchasers should therefore check with their retailer to ensure this publication correctly describes the products that are being offered for sale. All information supplied is to be used for general reference purposes only and is on the understanding that Electrolux Home Products Pty Ltd (Australia) and Electrolux (NZ) Ltd (New Zealand) will not be liable for any loss, liability or damage of whatever kind arising as a result of reliance on such information. Colours of products illustrated are as close as printing limitations allow. Electrolux will at all times comply with its obligations pursuant to law including Trade Practices (Australian Consumer Law) Act and Regulations.

WARRANTY

This warranty only applies to Appliances purchased and used in Australia or New Zealand and used in normal domestic applications and is in addition to (and does not exclude, restrict, or modify in any way) any non-excludable statutory warranties in Australia or New Zealand. All warranties are subject to the conditions set out in the warranty card accompanying the product when purchased.

ELECTROLUX HOME PRODUCTS AUSTRALIA

telephone: 1300 363 640

fax: 1800 350 067

email: customercare@electrolux.com.au

web: www.electrolux.com.au

ELECTROLUX HOME PRODUCTS NEW ZEALAND

telephone: 09 573 2230

fax: 09 573 2221

email: customercare@electrolux.co.nz

web: www.electrolux.co.nz